

**Hybrid Module for EtherNet/IP and CIP-Safety**  
**Safe Digital Inputs and Outputs, Standard Universal Digital Channels, IO-Link**  
**Master Ports**  
**TBIP-L5-FDIO1-2IOL**

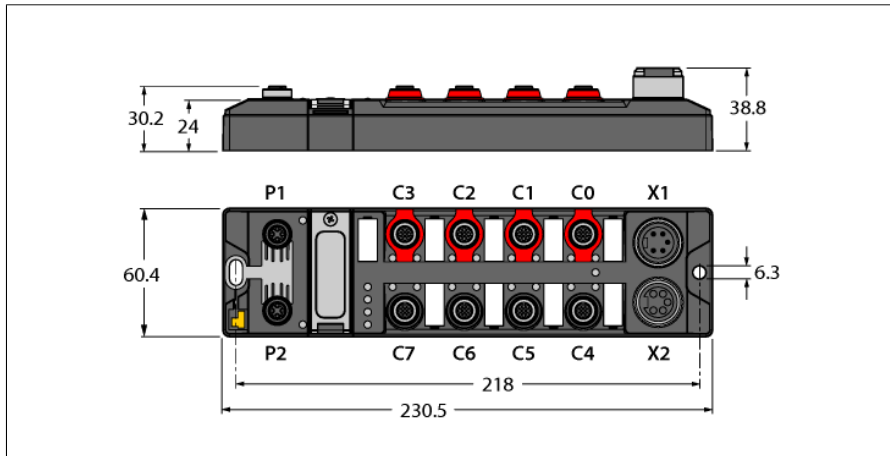

- EtherNet/IP™
- Integrated Ethernet switch
- 10 Mbps / 100 Mbps supported
- 2 x male M12, 4-pin, D-coded, Ethernet-Fieldbus connection
- Glass fiber reinforced housing
- Shock and vibration tested
- Fully potted module electronics
- Protection classes IP65, IP67, IP69K
- 7/8" connector for power supply, 5-pin
- Two safe digital SIL3-inputs
- 2 IO-Link Master V1.1 slots

<b>Type designation</b>	TBIP-L5-FDIO1-2IOL
Ident-No.	6814056
<b>Supply</b>	
Supply voltage	24 VDC
Admissible range	20.4...28.8 VDC
Voltage supply connection	5-pin male 7/8" connector X1
Electrical isolation	galvanic isolation of the voltage groups V1 and V2, voltages up to 500 VAC
<b>System data</b>	
Fieldbus transmission rate	10 Mbps/100 Mbps
Fieldbus connection technology	2 x M12, 4-pin, D-coded
Web server	integrated
Service interface	Ethernet via P1 or P2
<b>EtherNet/IP™</b>	
Addressing	acc. to EtherNet/IP™ specification
Quick Connect (QC)	< 150 ms
Device Level Ring (DLR)	supported
Class 1 connections (CIP)	3
<b>Safety Data</b>	
PL acc. to DIN EN 13849-1:2008	e
Category acc. to DIN EN 13849-1:2008	4
SIL according IEC 61508	3
Useful Lifetime	20 Jahre (EN ISO 13849-1)
<b>Safety Inputs OSSD</b>	
Low level signal voltage	EN 61131-2 Type 1 (< 5 V; < 0.5 mA)
High level signal voltage	EN 61131-2 Type 1 (> 15 V; > 2 mA)
Max. OSSD supply per channel	2 A per C0, C1, C2, C3, 1.5 A at 70 °C please consider derating as shown in Figure 1
Max. tolerance test pulse width	1 ms
Interval between 2 test pulses, minimum	20 ms at 1 ms test pulse width 15 ms at 0.5 ms test pulse width
<b>Safety Inputs floating/antivalent</b>	
Max. loop resistance	< 150 Ω
Max. cable length	max. 1 µF at 150 Ω , limited by cable capacitance
Test pulse, typical	0.6 ms
Test pulse, maximum	0.8 ms
Sensor supply	Power supply V AUX1/T1 max. 2 A, please consider derating as shown in Figure 1
Interval between 2 test pulses, minimum	900 ms
Additional information	No connection to external potential allowed

Figure 1

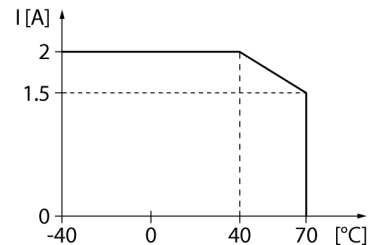
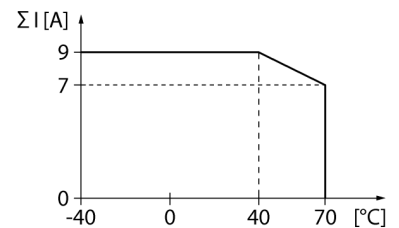

Figure 2



# Hybrid Module for EtherNet/IP and CIP-Safety

## Safe Digital Inputs and Outputs, Standard Universal Digital Channels, IO-Link Master Ports

### TBIP-L5-FDIO1-2IOL

---

#### Safety Outputs

Output current in off state	< 5 V
Output current in off state	< 1 mA
	, suitable for inputs according to EN 61131-2 Type 1
Test pulse, typical	0.5 ms
Test pulse, maximum	1.25 ms
Interval between 2 test pulses, typical	500 ms
Interval between 2 test pulses, minimum	250 ms
Actuator power supply	Versorgung V AUX1/T1 max. 2 A
	, please consider derating as shown in Figure 1
Max. output current	2 A (resistive)
	, 1 A (inductive)
Additional information	The load must be mechanically or electrically inert to tolerate the test pulses.
	When configured as a PPM switching output the negative pole of the load should be wired to the M-terminal of the corresponding output (Pin 2).

---

#### Digital inputs

Connectivity inputs	M12, 5-pin
Input type	PNP
Switching threshold	EN 61131-2 Typ 3, PNP
Low level signal voltage	< 5 V
High level signal voltage	> 11 V
Low level signal current	< 1.5 mA
High level signal current	> 2 mA
Input delay	2.5 ms
Sensor supply	C4, C5: FSO0 max. 2 A; 500 mA per input
	C6: V AUX1 max. 2 A
	C7: FSO1 max. 2 A
	, please consider derating as shown in Figure 1
Electrical isolation	Galvanically isolated to the fieldbus
	Voltage proof up 500 VDC

---

#### Connectivity outputs

Output current per channel	M12, 5-pol
	0.5 A, short-circuit-proof,
	max. 2 A (resistive)/1 A (inductive) all outputs
Actuator power supply	C4, C5: FSO0 max. 2 A; 500 mA per input
	C6: V AUX1 max. 2 A
	C7: FSO1 max. 2 A
	, please consider derating as shown in Figure 1

---

#### IO-Link

Number of channels	2
IO-Link specification	Version 1.1
IO-Link port type	Class A and Class B
Frame type	supports all specified frame types
Supported devices	max. 32 byte input/32 byte output
Transmission rate	4.8 kbps (COM 1) / 38.4 kbps (COM 2) / 230 kbps (COM 3)
Power supply	Versorgung V AUX1/T1 max. 2 A
	, please consider derating as shown in Figure 1

---

#### Standard/Directive conformity

Vibration test	acceleration to 20 g
	acc. to EN 60068-2-6
Shock test	acc. to EN 60068-2-27
Drop and topple	acc. to EN 60068-2-31/IEC 60068-2-32
Electromagnetic compatibility	acc. to EN 61131-2
Approvals and certificates	CE,
	FCC,
	UV-resistant in accordance with DIN EN ISO
	4892-2A (2013)
UL Certificate	cULus LISTED 21 W2, Encl.Type 1 IND.CONT.EQ.

## Hybrid Module for EtherNet/IP and CIP-Safety

### Safe Digital Inputs and Outputs, Standard Universal Digital Channels, IO-Link Master Ports

#### TBIP-L5-FDIO1-2IOL

---

**General Information**

Dimensions (W x L x H)	60.4 x 230.4 x 39mm
Operating temperature	-40...+70 °C
Storage temperature	-40 °C ... +85 °C
Altitude	max. 5000 m
Protection class	IP65 IP67 IP69K
Housing material	PA6-GF30
Housing color	Black
Window material	Lexan
Material screw	303 stainless steel
Material label	Polycarbonate
Halogen-free	yes
Mounting	2 mounting holes □ 6.3 mm

---

The data sheet serves as advance information. For definitive values see the corresponding product manual. In this respect, no liability for completeness and accuracy can be applied to the content of this data sheet.

**Hybrid Module for EtherNet/IP and CIP-Safety**  
**Safe Digital Inputs and Outputs, Standard Universal Digital Channels, IO-Link**  
**Master Ports**  
**TBIP-L5-FDIO1-2IOL**

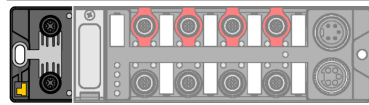

**Accessories**  
Ethernet cable (example):  
RSSD RSSD 441-2M  
Ident. no. U-02482

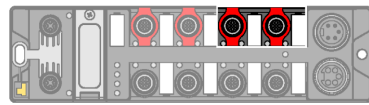
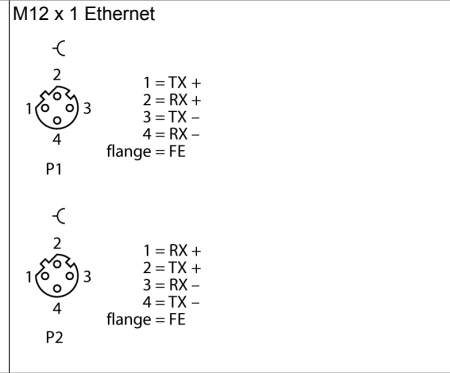

**Accessories**  
Actuator and sensor cable/PUR connection cable (example):  
RKC4.5T-2-RSC4.5T/TXY  
Ident. no. 6629805

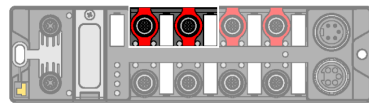
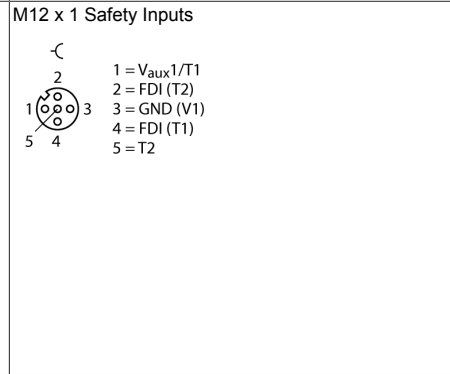

**Accessories**  
Actuator and sensor cable/PUR connection cable (example):  
RKC4.5T-2-RSC4.5T/TXY  
Ident. no. 6629805

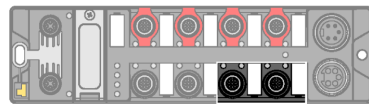
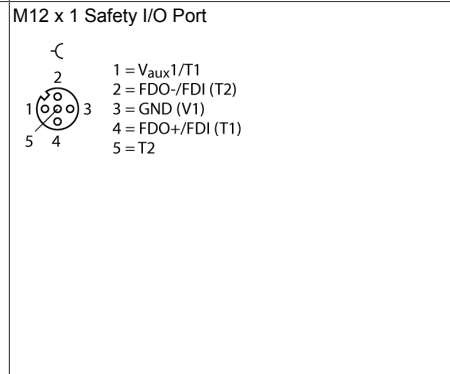

**Accessories**  
Actuator and sensor cable/PUR connection cable (example):  
RKC4.5T-2-RSC4.5T/TXL  
Ident. no. 6625612

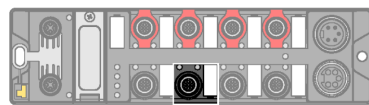
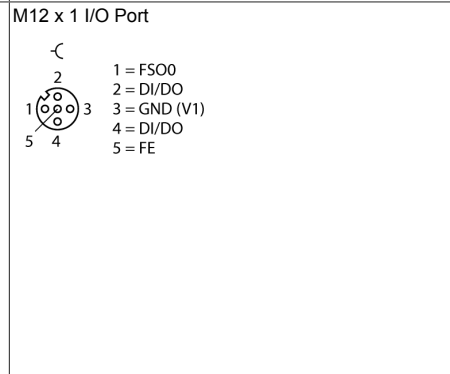

**Accessories**  
Actuator and sensor cable/PUR connection cable (example):  
Connection of a class A device:  
RKC4T-2-RSC4T/TXL  
Ident. no. 6625604  
Connection of a class B device:  
RKC4.5T-2-RSC4.5T/TXL  
Ident. no. 6625612

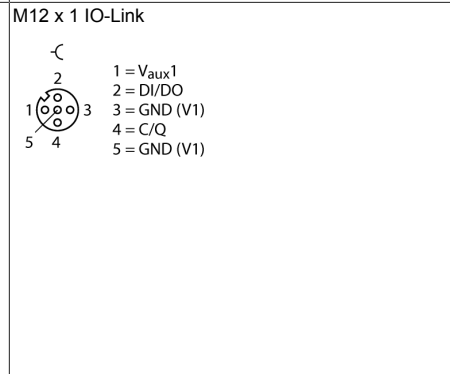

**Hybrid Module for EtherNet/IP and CIP-Safety**  
**Safe Digital Inputs and Outputs, Standard Universal Digital Channels, IO-Link**  
**Master Ports**  
**TBIP-L5-FDIO1-2IOL**

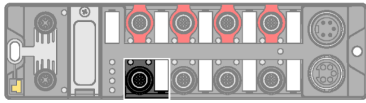

**Accessories**

Actuator and sensor cable/PUR connection cable (example):

Connection of a class A device:

RKC4T-2-RSC4T/TXL

Ident. no. 6625604

Connection of a class B device:

RKC4.5T-2-RSC4.5T/TXL

Ident. no. 6625612

M12 x 1 IO-Link

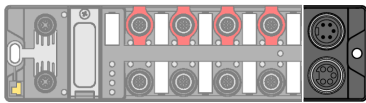
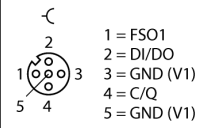

**Accessories**

Power supply cable (example):

RSM RKM 50-2M

Ident. no. U2282-0

7/8" Power Supply

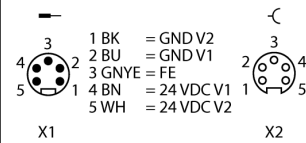

## Hybrid Module for EtherNet/IP and CIP-Safety

### Safe Digital Inputs and Outputs, Standard Universal Digital Channels, IO-Link Master Ports

#### TBIP-L5-FDIO1-2IOL

##### Module Status LED

LED	Color	Status	Description
ETH1/ETH2	Green	ON	Ethernet link (100 Mbps)
		flashing	Ethernet communication (100 Mbps)
		OFF	No Ethernet link
NS	Green	On	Active connection to a master
		flashing	Connection has been established but not fully completed
	Red	On	Communication Error
		flashing	One or more I/O connections have the time-out status.
Red/Green	Alternating	Faulty self-test or configuration	
MS	Green	On	Diagnostics disabled
	Green	Flashing	When used as a stand-alone device: Device is in protective mode, an EtherNet/IP™ client is accessing the standard I/Os.
	Red	On	Critical error
	Red	Flashing	Correctable error
	Green/Red	Flashing alternately	Faulty self-test or configuration
PWR	Green	ON	Power supply V, OK
		OFF	V, power off or below defined tolerance of 18 V

##### LED Status I/O

LED	Color	Status	Description
0...3	Green	ON	Channel active
		flashing	Self test
	Red	ON	Discrepancy
		flashing	Cross circuit
4...7	Green	ON	Channel active
		flashing	Self test (input only)
	Red	ON	Discrepancy, overload (output only)
		flashing	Cross circuit
8...11	Green	ON	Channel active
	Red	ON	Overload (output only)
		flashing	Overload of supply
Green/Red	alternating	Channel active and overload of supply (input only)	
12, 14 (IO-Link Port 1 and 2) IO-Link Mode	Green	flashing	IO-Link communication, process data valid
		Red	flashing
	Red	ON	IO-Link supply OK, no IO-Link Communication
		OFF	Port inactive
12, 14 (IO-Link Port 1 and 2) SIO Mode	Green	ON	Digital Input signal is present
		OFF	No input signal
13, 15	Green	ON	Digital input or output active
		Red	ON
	Red	flashing	Overload of supply
		OFF	Input or output inactive

**Hybrid Module for EtherNet/IP and CIP-Safety**  
**Safe Digital Inputs and Outputs, Standard Universal Digital Channels, IO-Link**  
**Master Ports**  
**TBIP-L5-FDIO1-2IOL**

**Process Data Mapping of the Single Protocols**

For more details on the corresponding protocols see manual.